

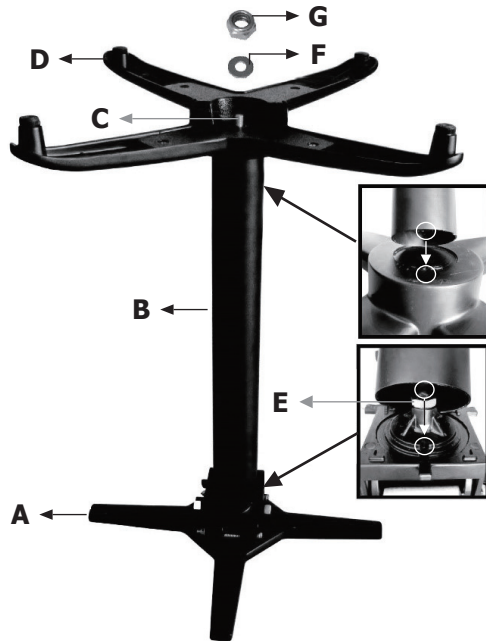







# BOLERO

## GP773 Bolero Aluminium Flip Top Base (Black)

### Assembly Instructions



A		1pc
B		1pc
C		1pc
D		1pc
E		2pcs
F		1pc
G		1pc

UK	0845 146 2887	Fourth Way, Avonmouth, Bristol, BS11 8TB United Kingdom
NL	0800 – 29 1 29	
	040 – 2628080	
FR	0800 - 29 2 29	
	01 60 34 28 80	
DE	0800 – 1860806	
IT	N/A	
ES	901-100 133	
PT	901-100 133	
AU	1300 225 960	15 Badgally Road, Campbelltown, 2560, NSW, Australia



#### Important!

Please note screws required to fix the base to the Bolero predrilled table tops are supplied with the table top carton.

Before assembly, carefully remove all packaging and ensure all parts are present. Please periodically check and tighten assembly.

Once assembled please do not attempt to move or lift the table by pulling the table top as this will cause damage to top!

GP773\_A5\_v3\_171229